

工学部 講義室案内図(その1)

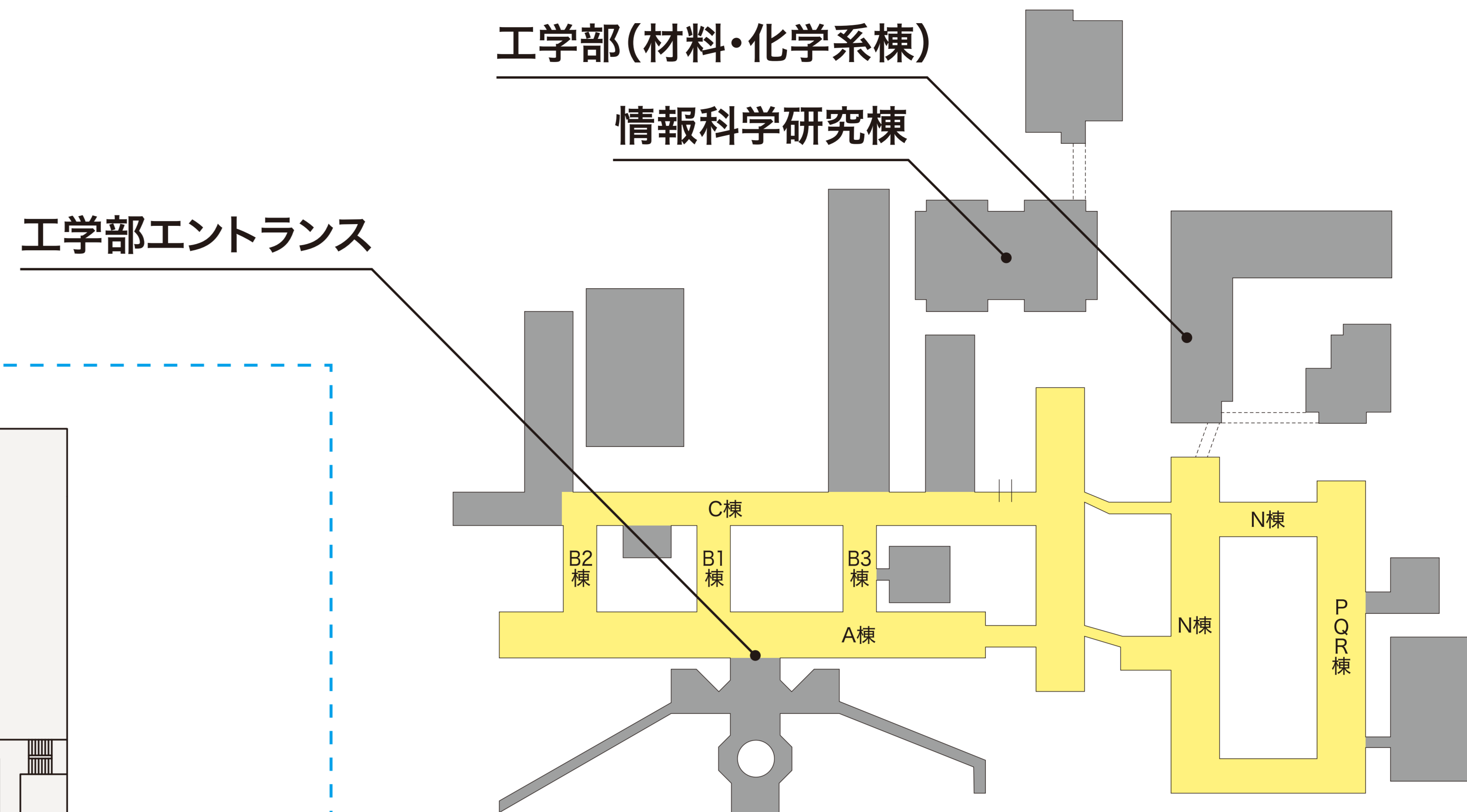
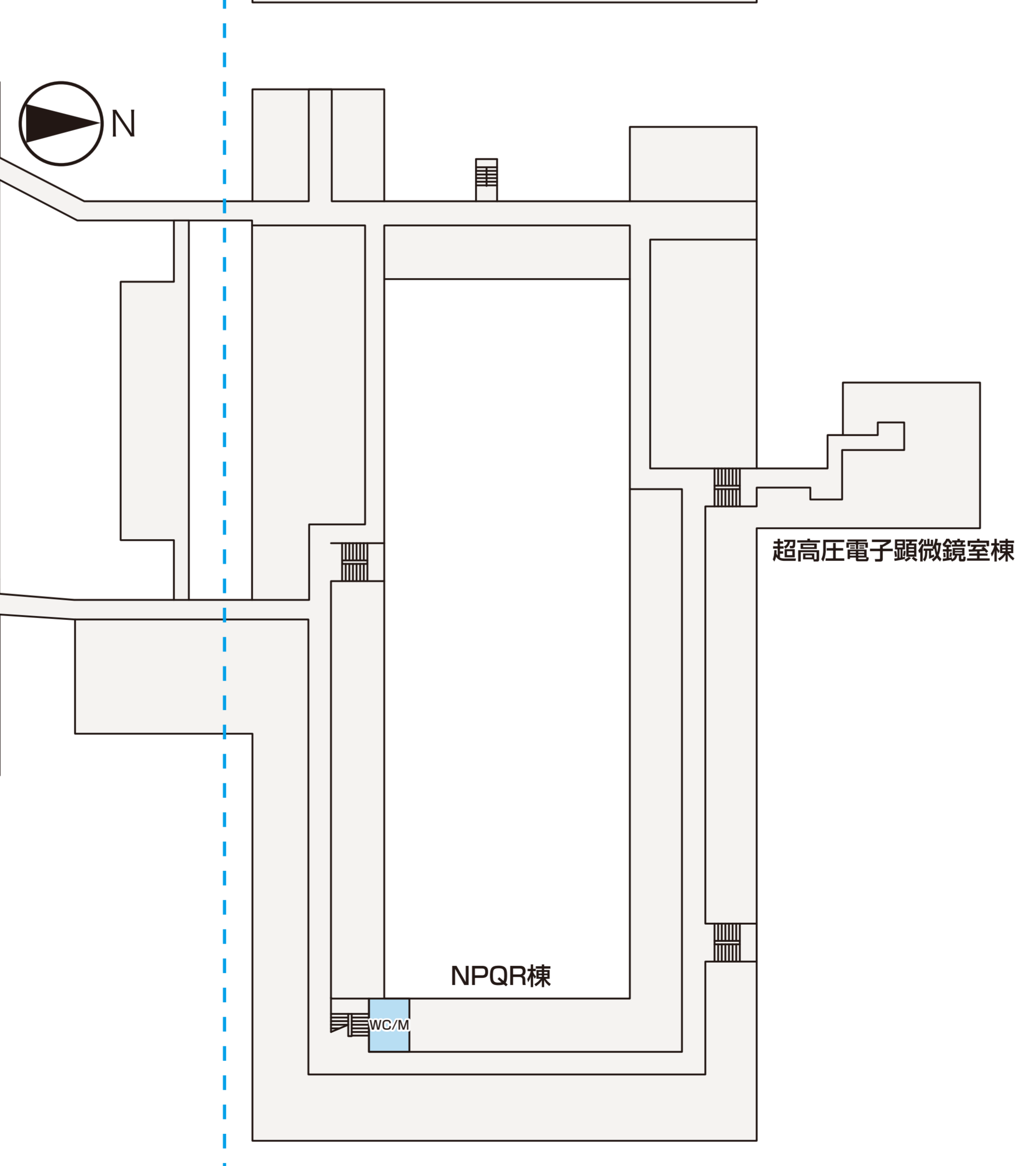
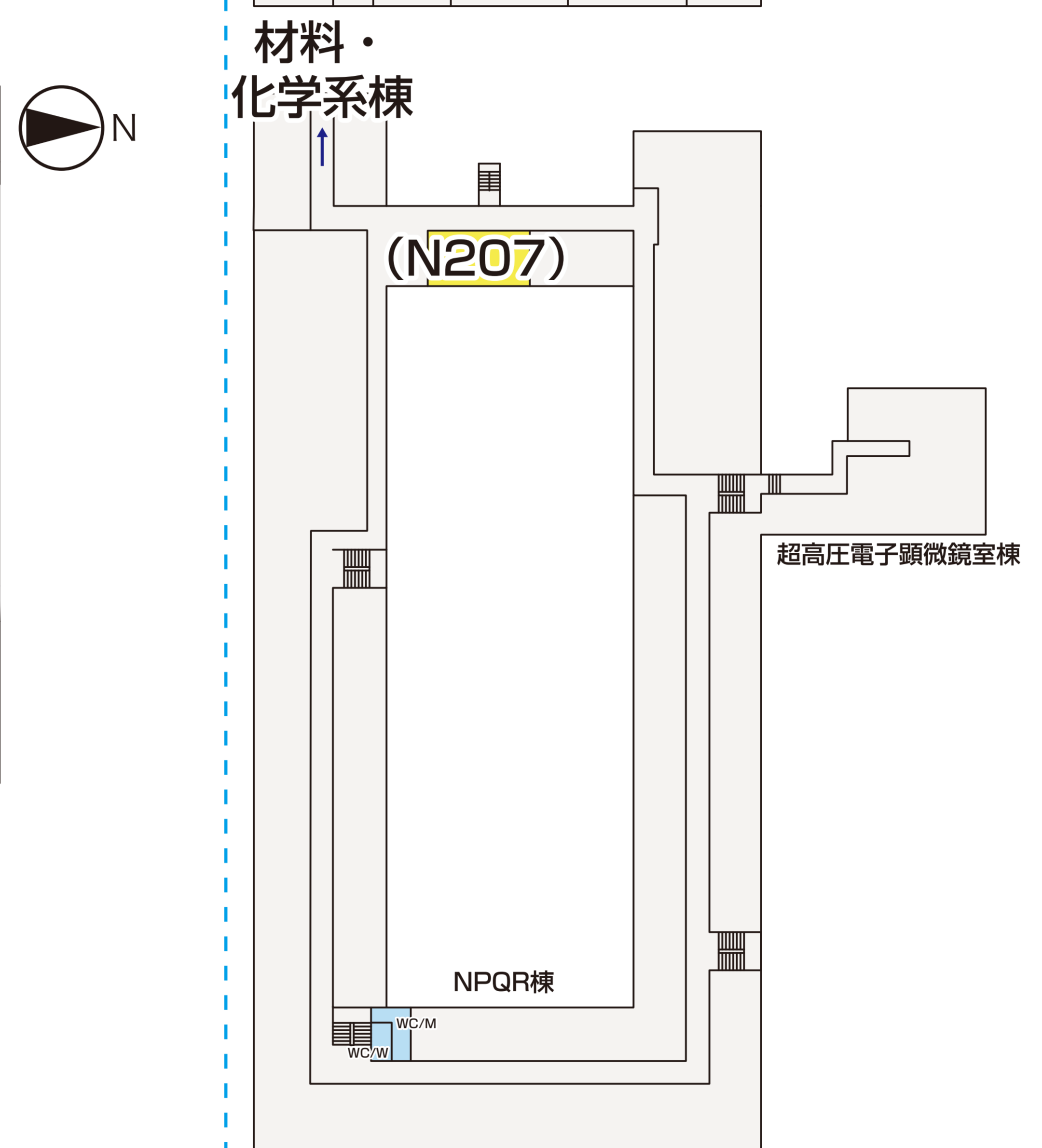
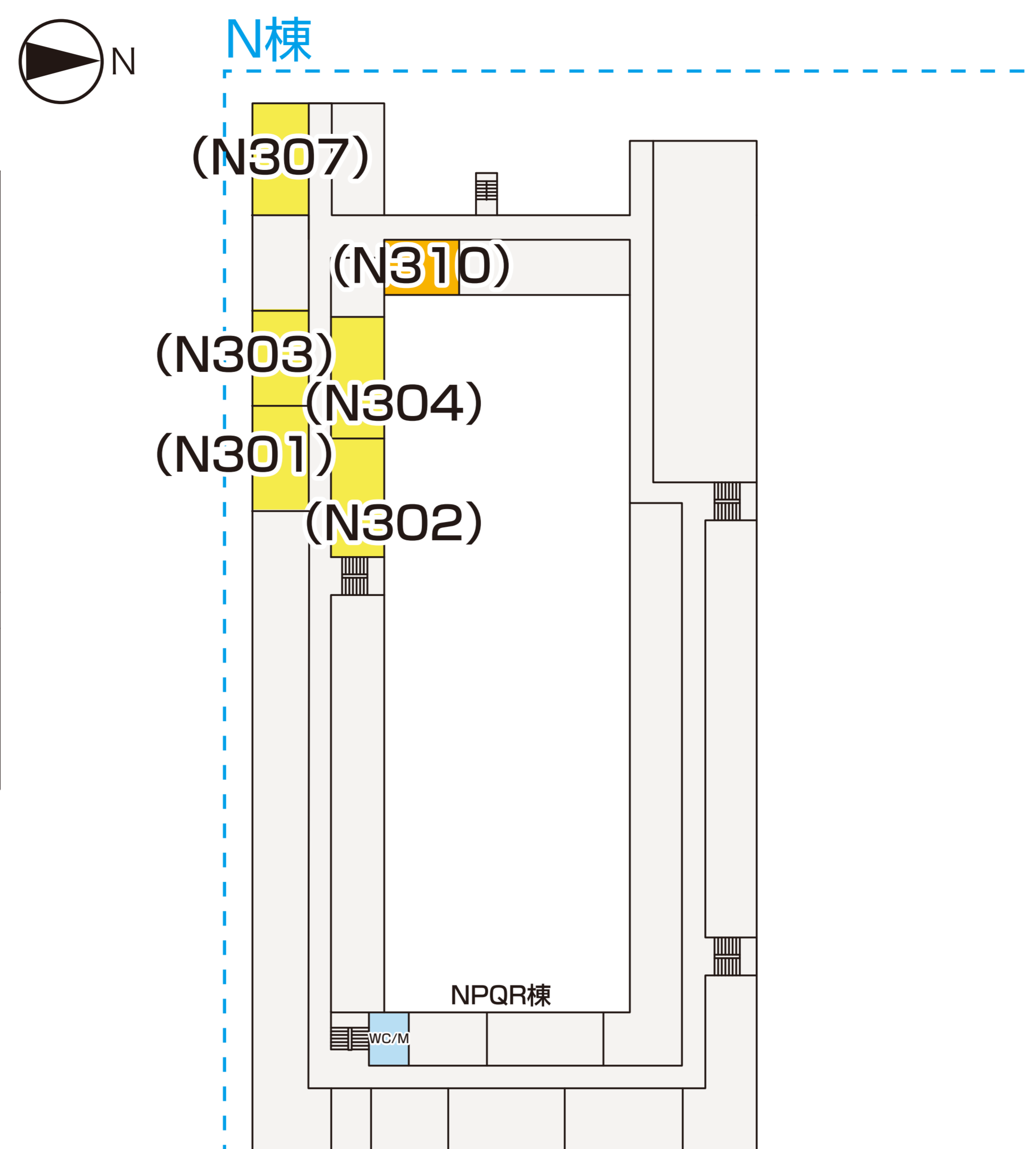
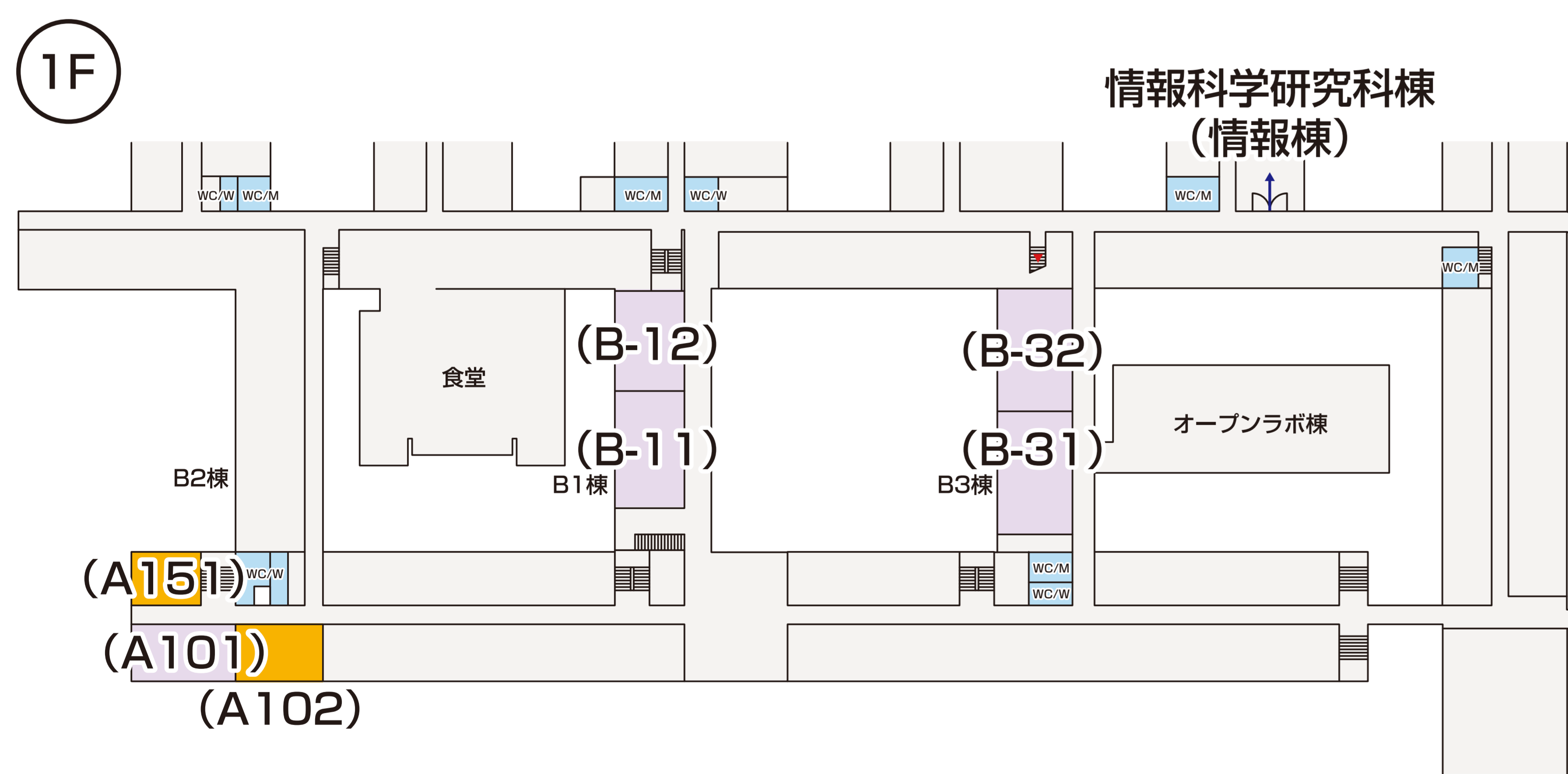
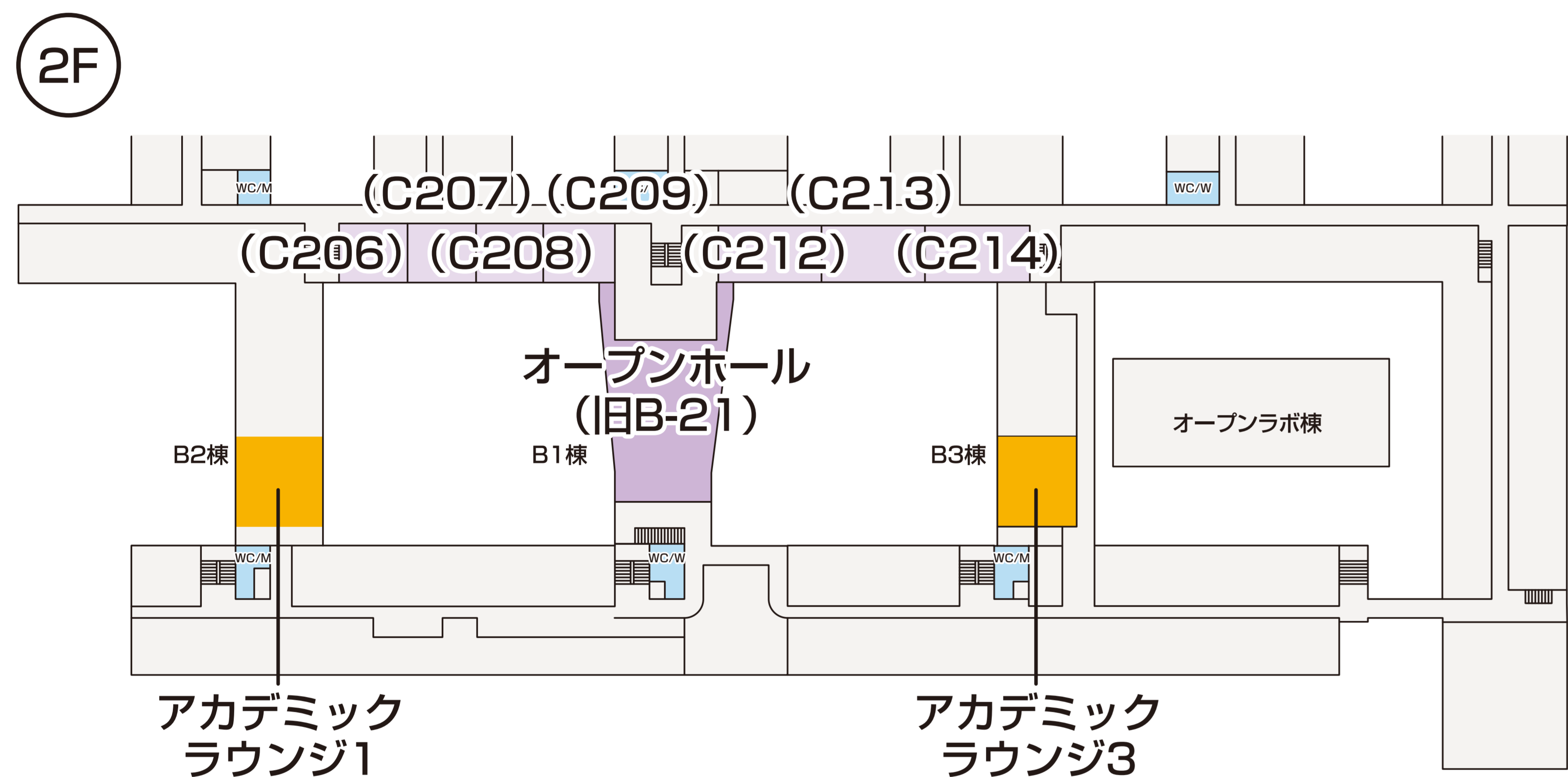
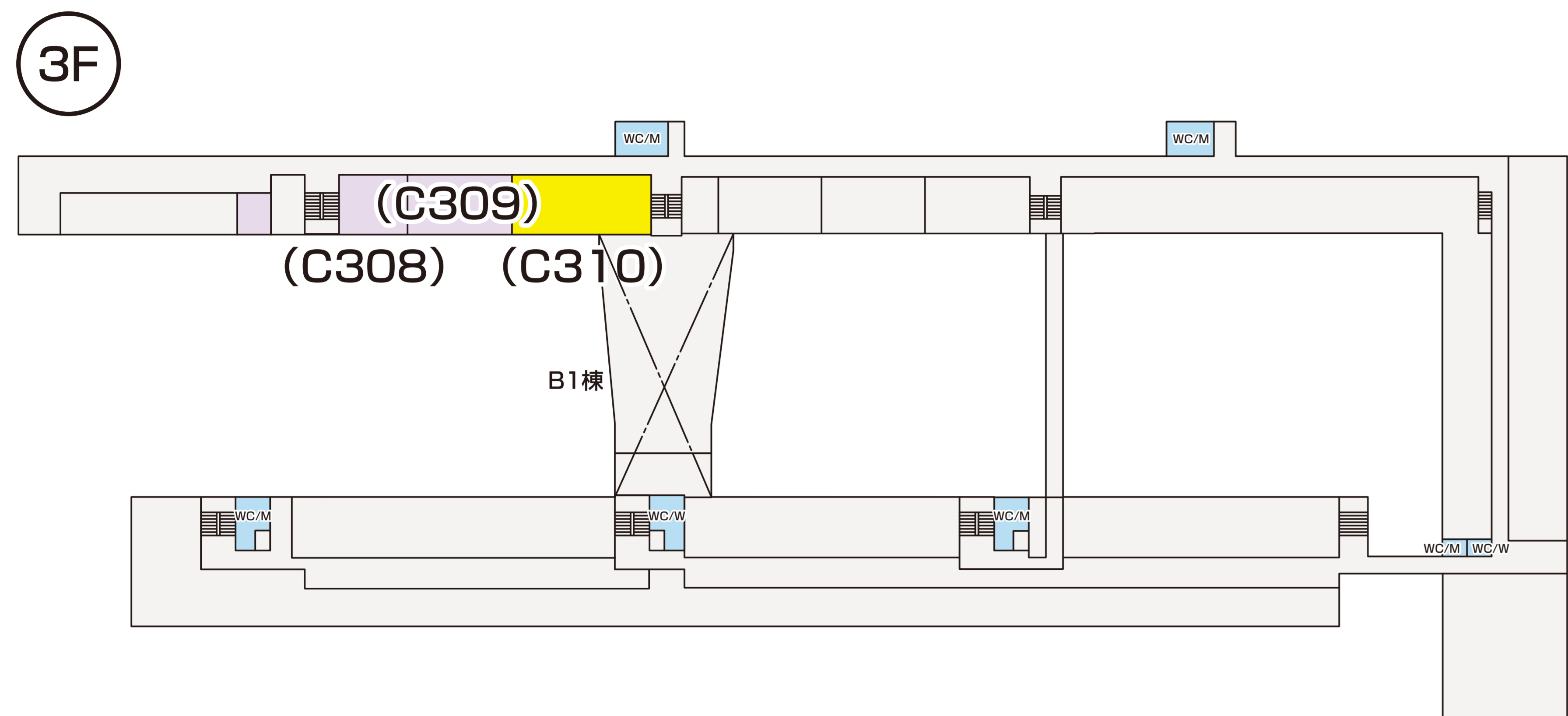

| | | | |
|-----------|-----------------------------|--------------------------------------|--|
| 1F | V-1 | (A101教室) | |
| | 試写室① | (A102教室) | |
| | V-2 | (B11 教室) | |
| | V-3 | (B12 教室) | |
| | V-4 | (B31 教室) | |
| | V-5 | (B32 教室) | |
| 2F | V-6 | (C206教室) | |
| | V-7 | (C207教室) | |
| | V-8 | (C208教室) | |
| | V-9 | (C209教室) | |
| | V-10 | (C212教室) | |
| | V-11 | (C213教室) | |
| | V-12 | (C214教室) | |
| | CS-4 | (オープンホール) | |
| | | | 8/29 15:20-16:40は (高等教育推進機構、 N304教室) |
| | 3F | V-13 | (C308教室) |
| | | V-14 | (C309教室) |
| | | V-15 | (C310教室) |
| VI-1 | | (N207教室) | |
| VI-2 | | (N301教室) | |
| VI-3 | | (N302教室) | |
| 2F | VI-4 | (N303教室) | |
| | VI-5 | (N304教室) | |
| | VI-6 | (N307教室) | |
| | VI-9 | 8/29 10:40-12:00 (材料化学系棟 MC204教室) | |
| | 2F | 8/29 15:20-16:40 (アカデミックラウンジ1) | |
| | 2F | 8/30,8/31(材料化学系棟 MC204教室) | |
| 2F | VI-10 | 8/30 10:40-12:00 (アカデミックラウンジ1) | |
| | その他の日時は(材料化学系棟、 MC208教室) | | |
| 2F | VI-14 | (アカデミックラウンジ3) | |

工学部 講義室案内図(その2:材料・化学系棟)

3F

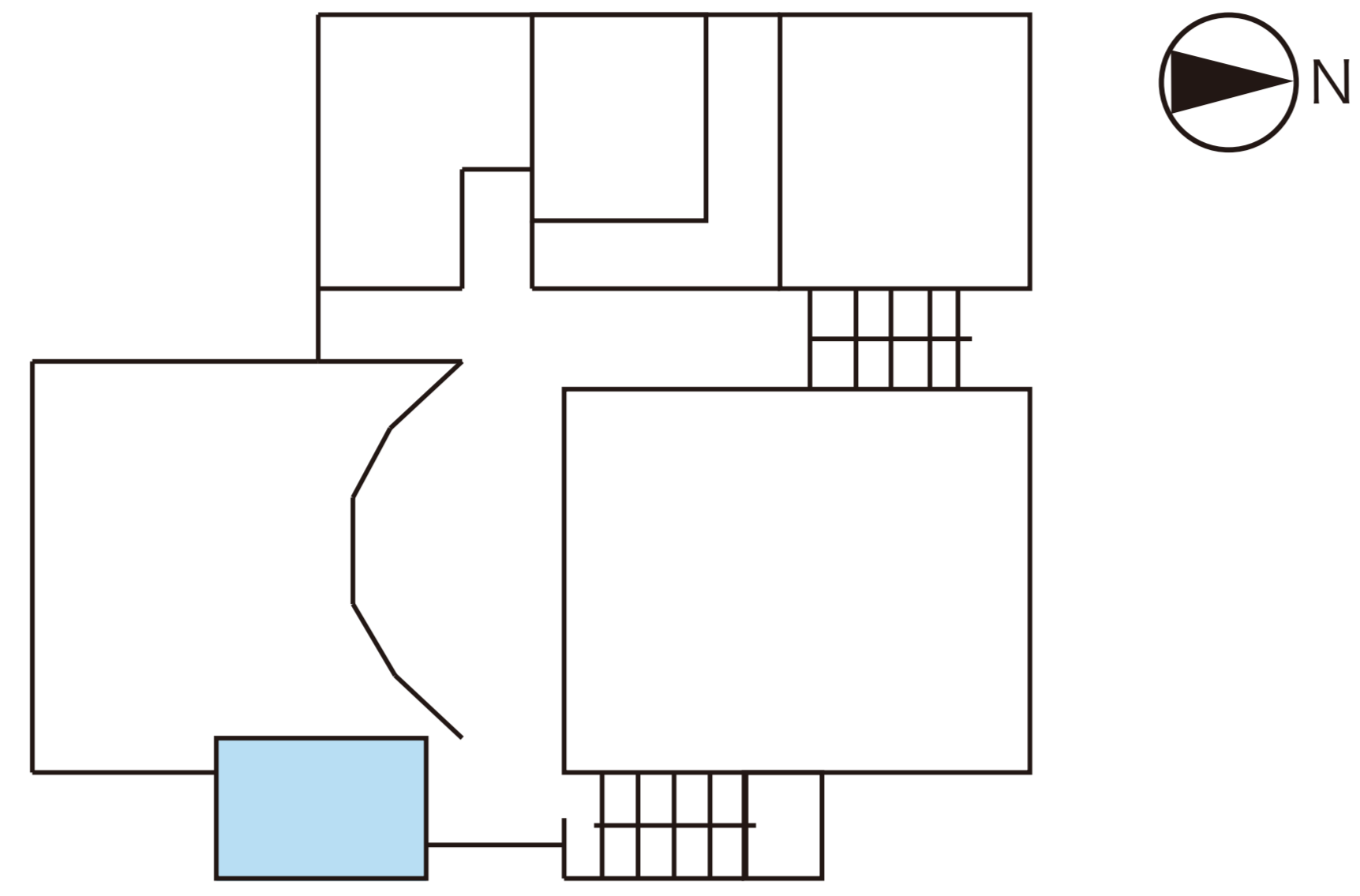

2F

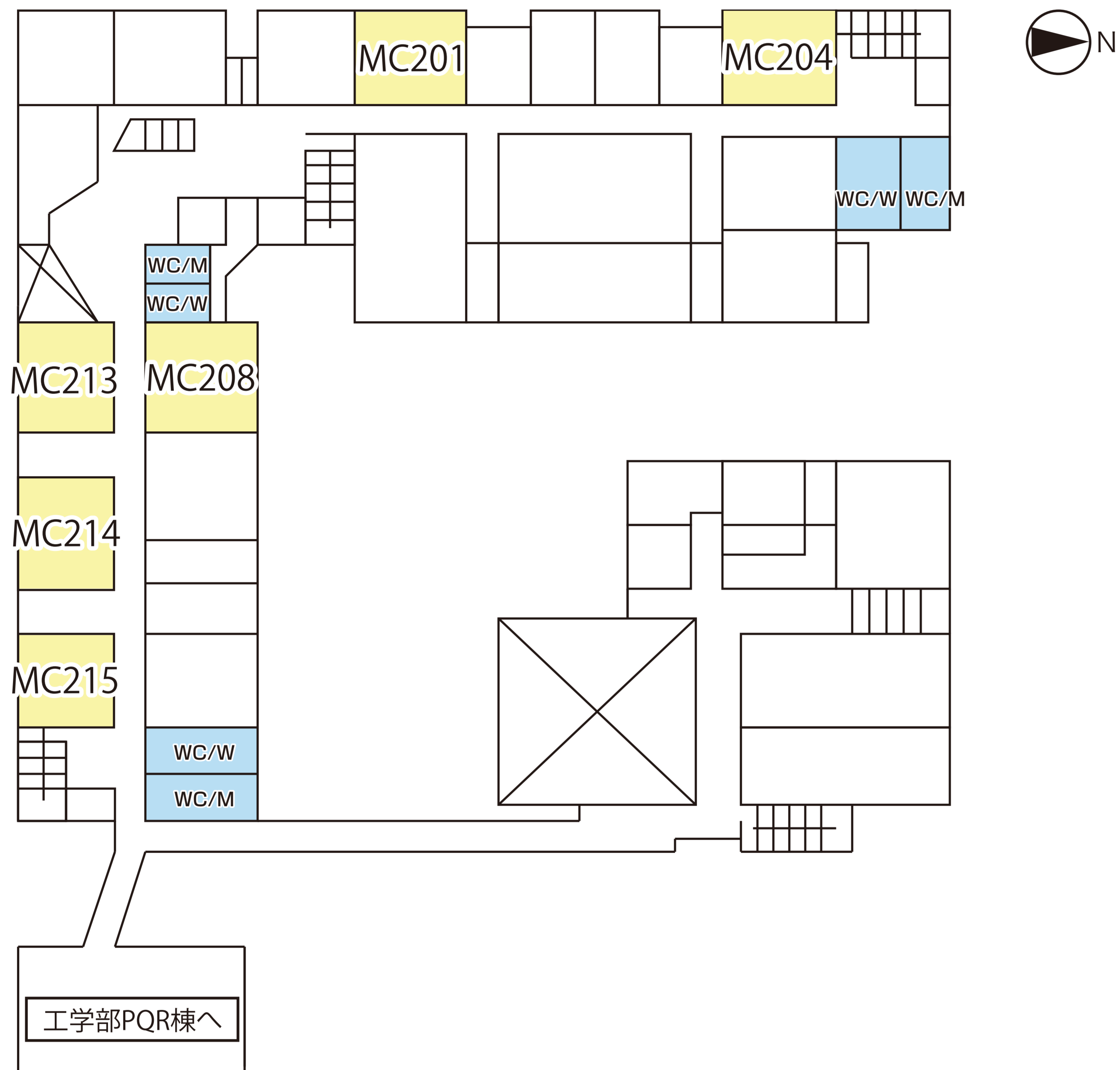

1F

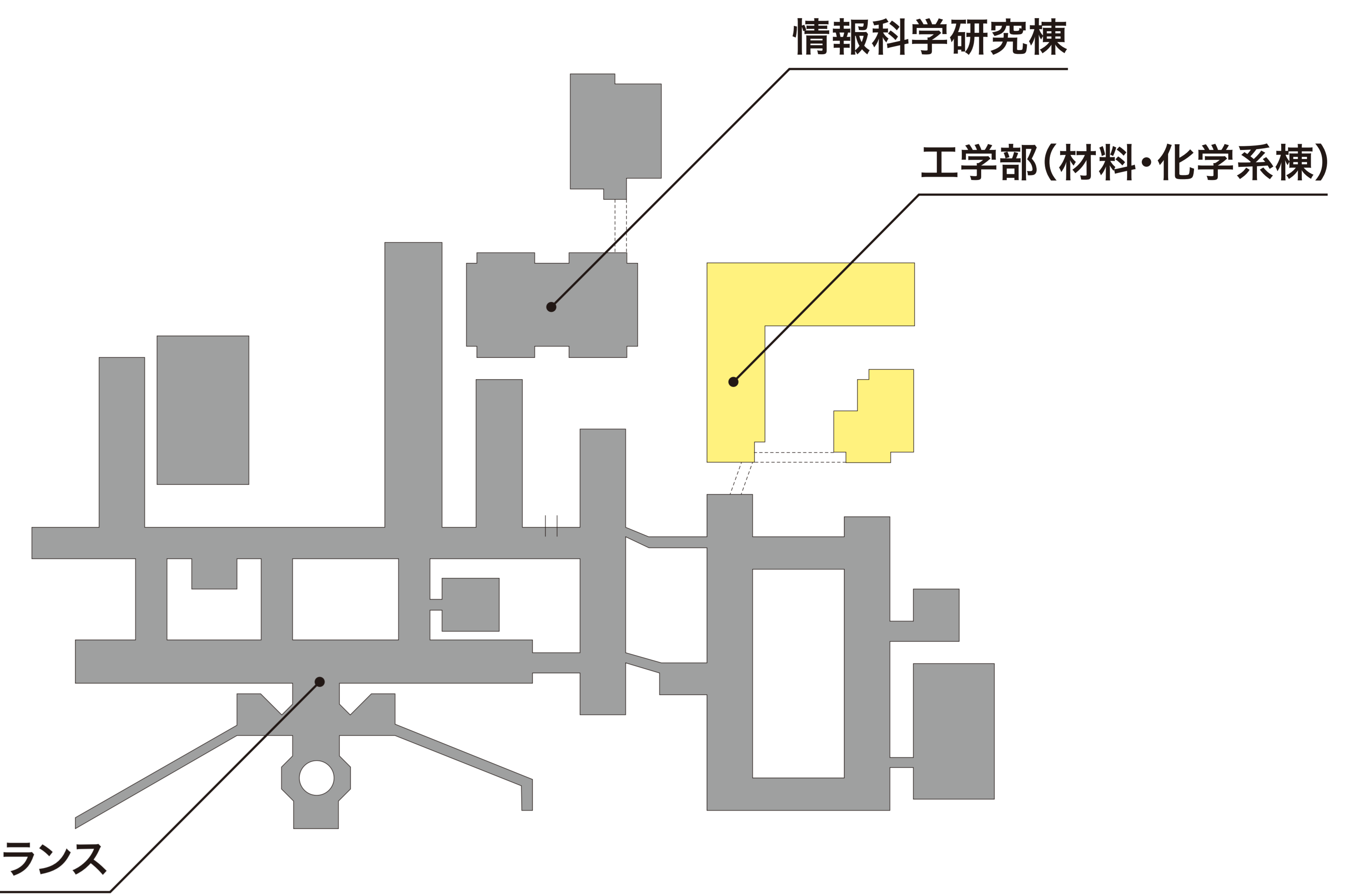
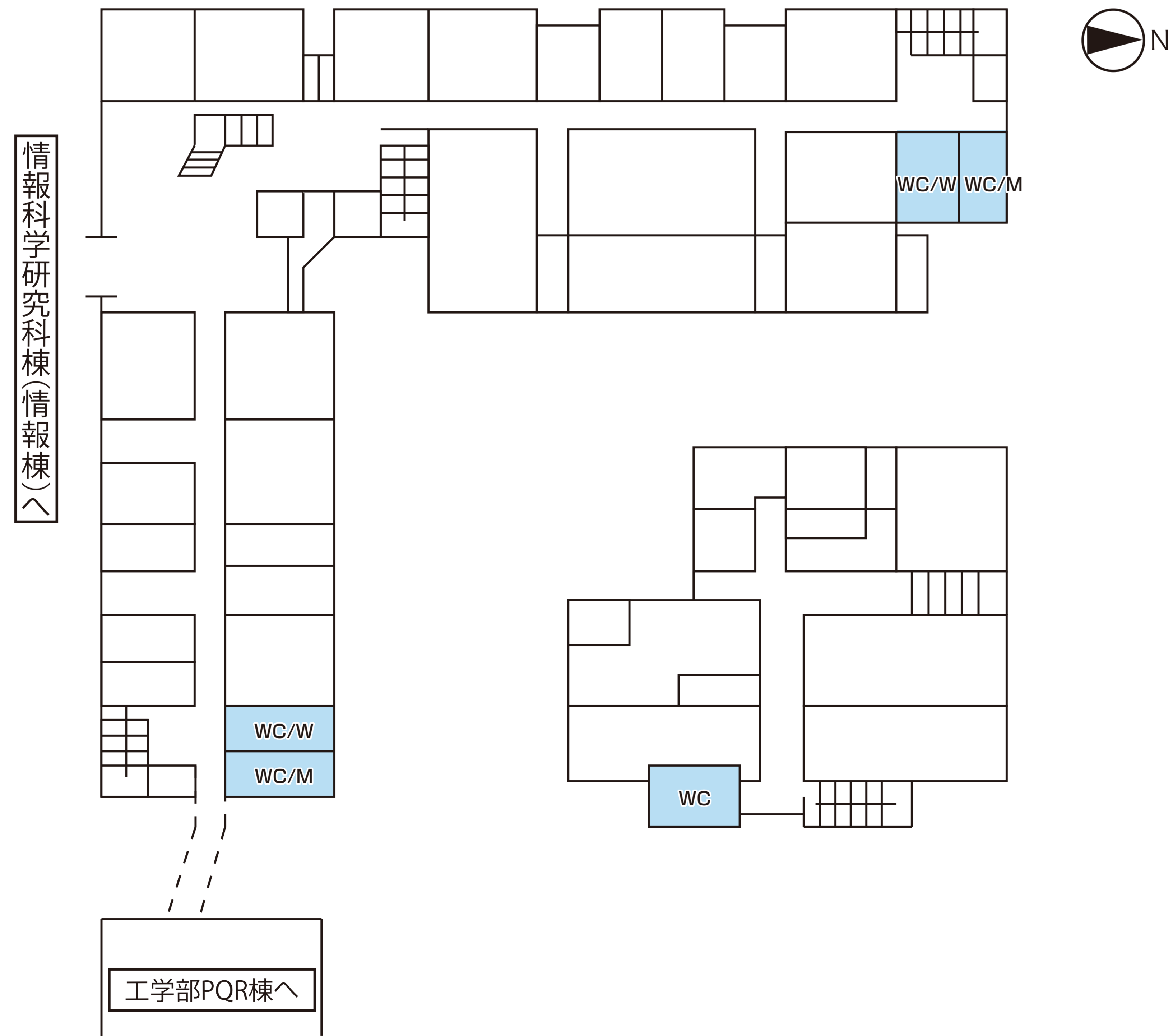

| | | | |
|--------|-------|-------|---|
| 2 F | VI-8 | | (MC201教室) |
| | VI-9 | | 8/29 10:40-12:00(MC204教室) 8/29 15:20-16:40(工学部 アカデミックラウンジ1) 8/30,8/31(MC204教室) |
| | VI-10 | | 8/29 (MC208教室) 8/30 9:00-10:20 (MC208教室) 8/30 10:40-12:00(工学部 アカデミックラウンジ1) 8/31(MC208教室) |
| | VI-11 | | (MC213教室) |
| | VI-12 | | (MC214教室) |
| | VI-13 | | (MC215教室) |

情報科学研究棟 講義室案内図

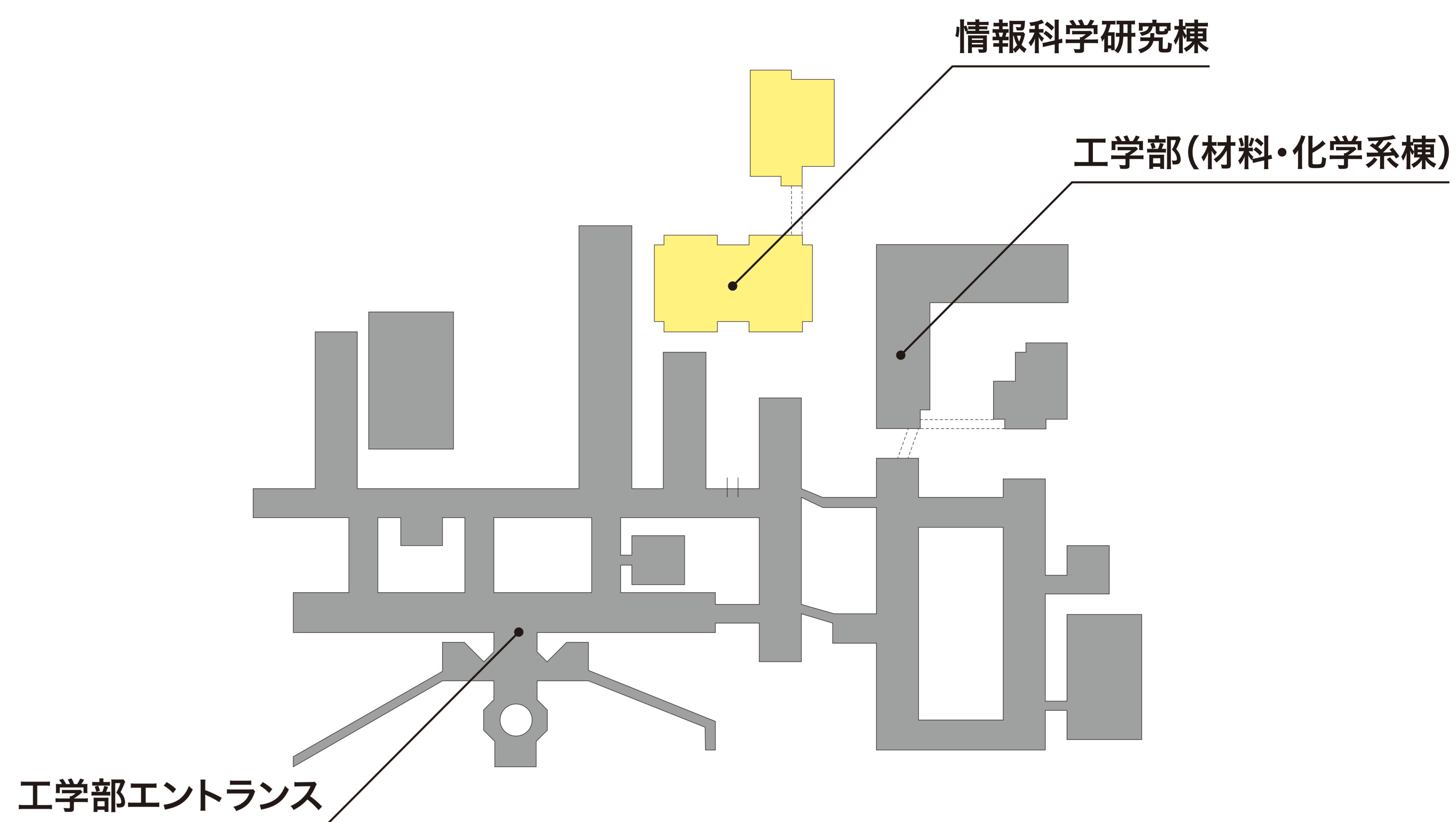
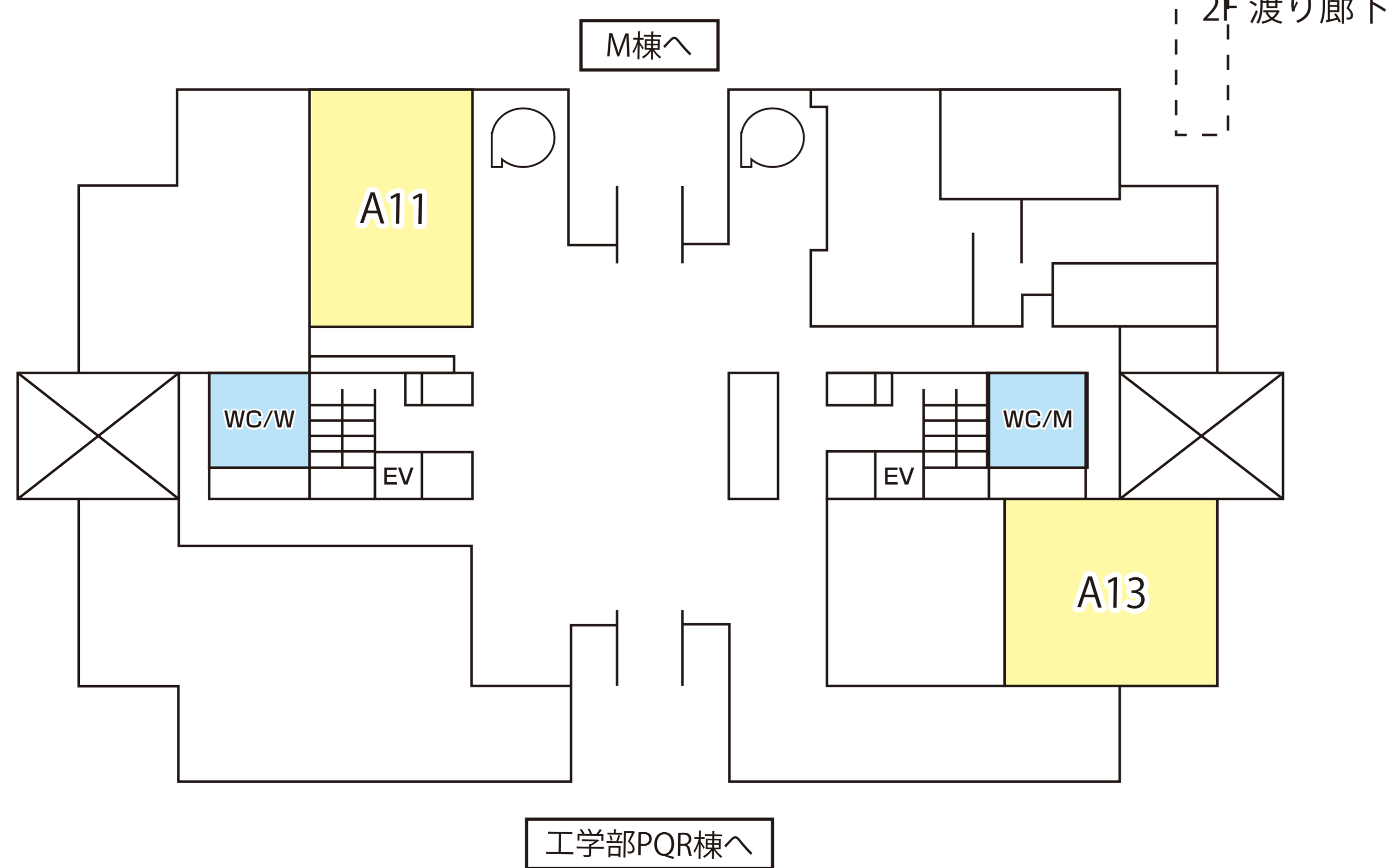
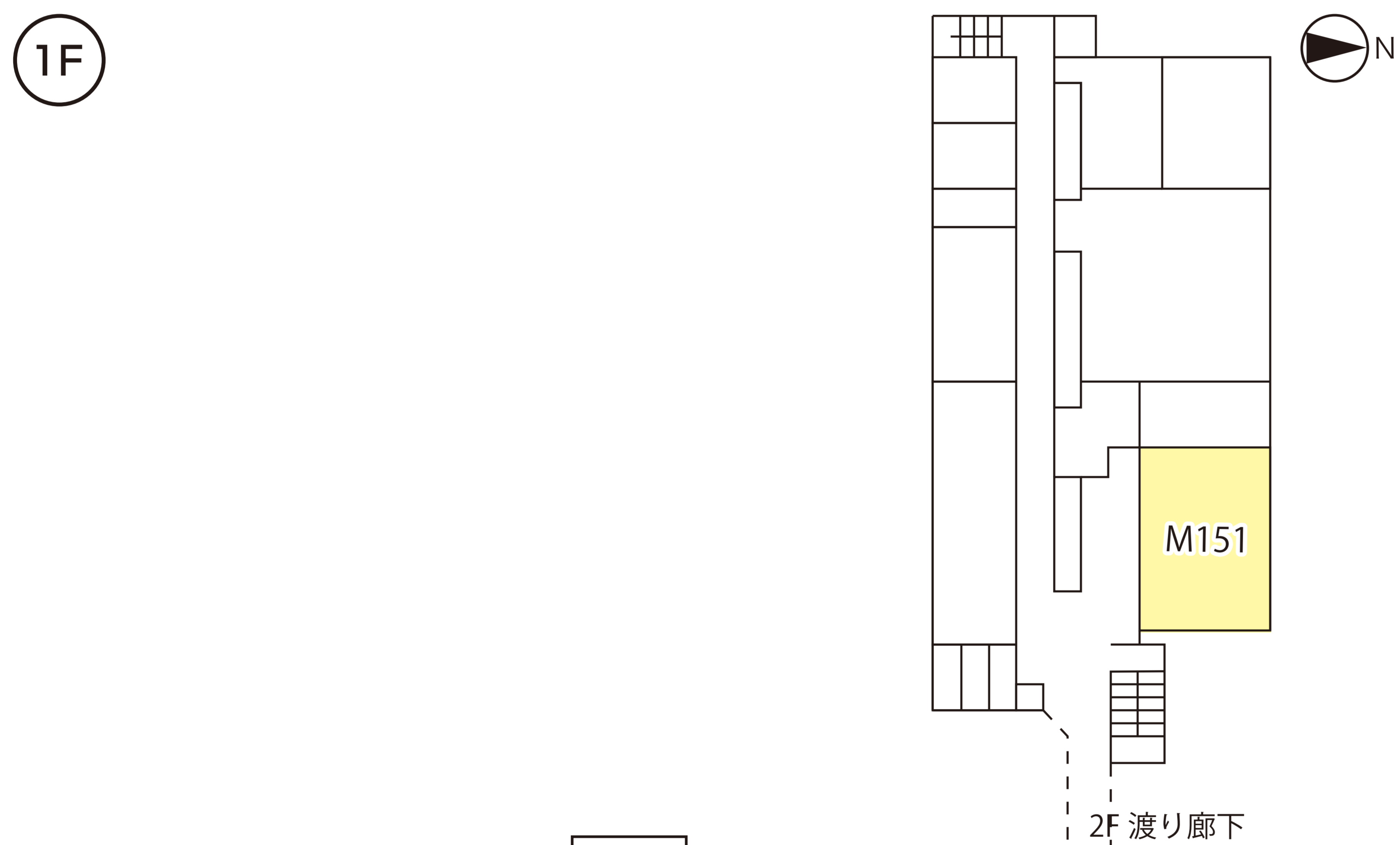
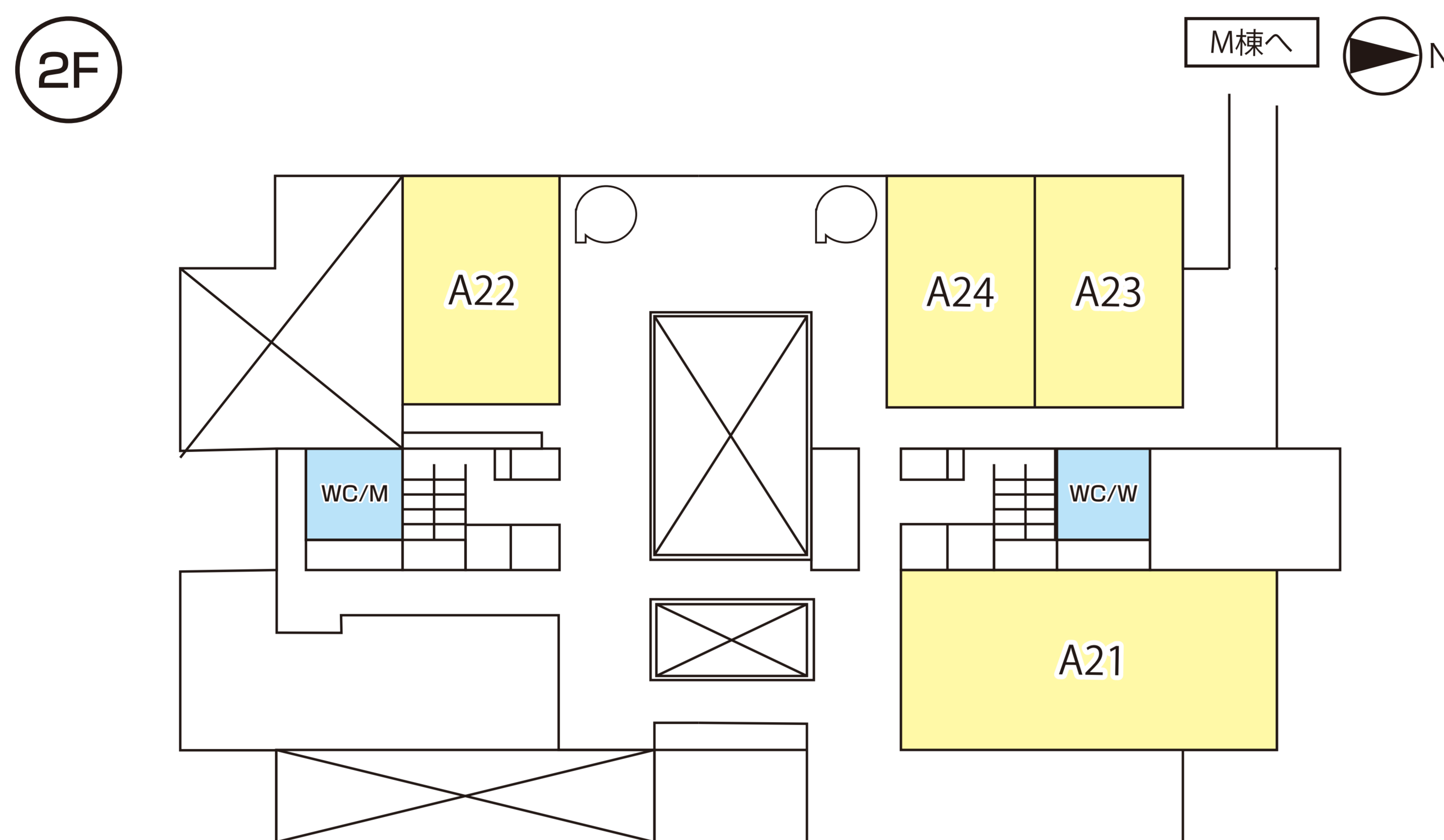
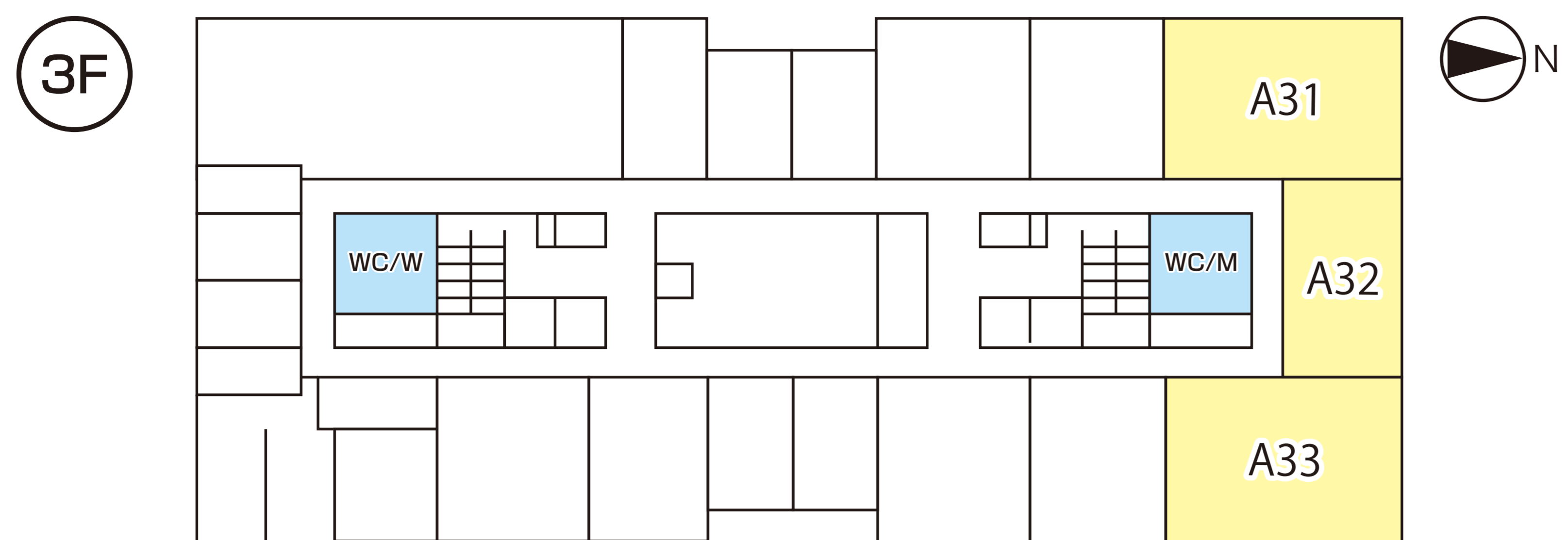

| | | | |
|--------|-------|-------|-----------|
| 2 F | VI- 7 | | (A21 教室) |
| | VI-15 | | (A22 教室) |
| | VI-16 | | (A23 教室) |
| | VI-17 | | (A24 教室) |
| 3 F | VI-18 | | (A31 教室) |
| | VI-19 | | (A32 教室) |
| | VI-20 | | (A33 教室) |
| 1 F | VII-1 | | (A11 教室) |
| | VII-2 | | (A13 教室) |
| | VII-3 | | (M151 教室) |

■ 高等教育推進機構 講義室案内図

3F

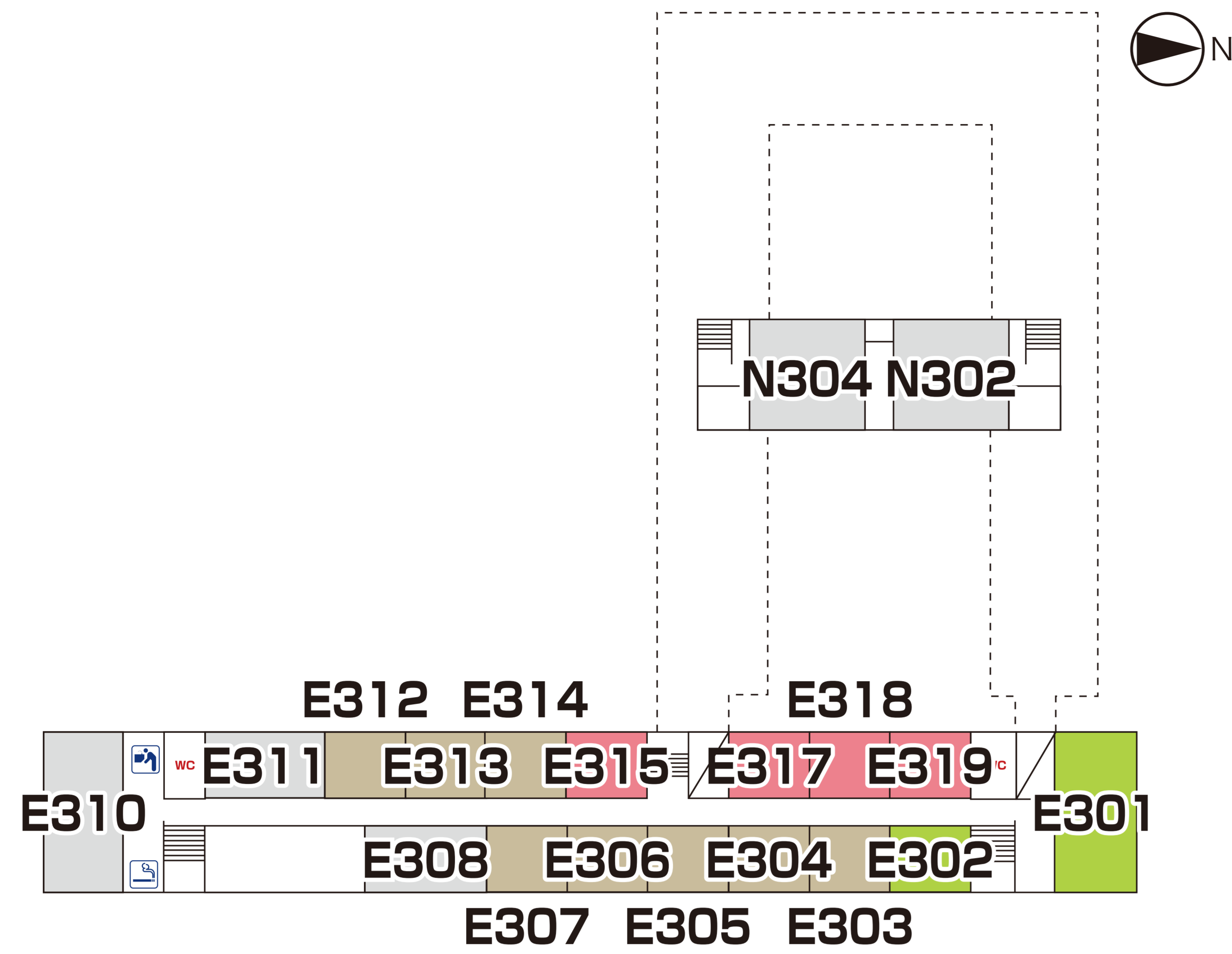

2F

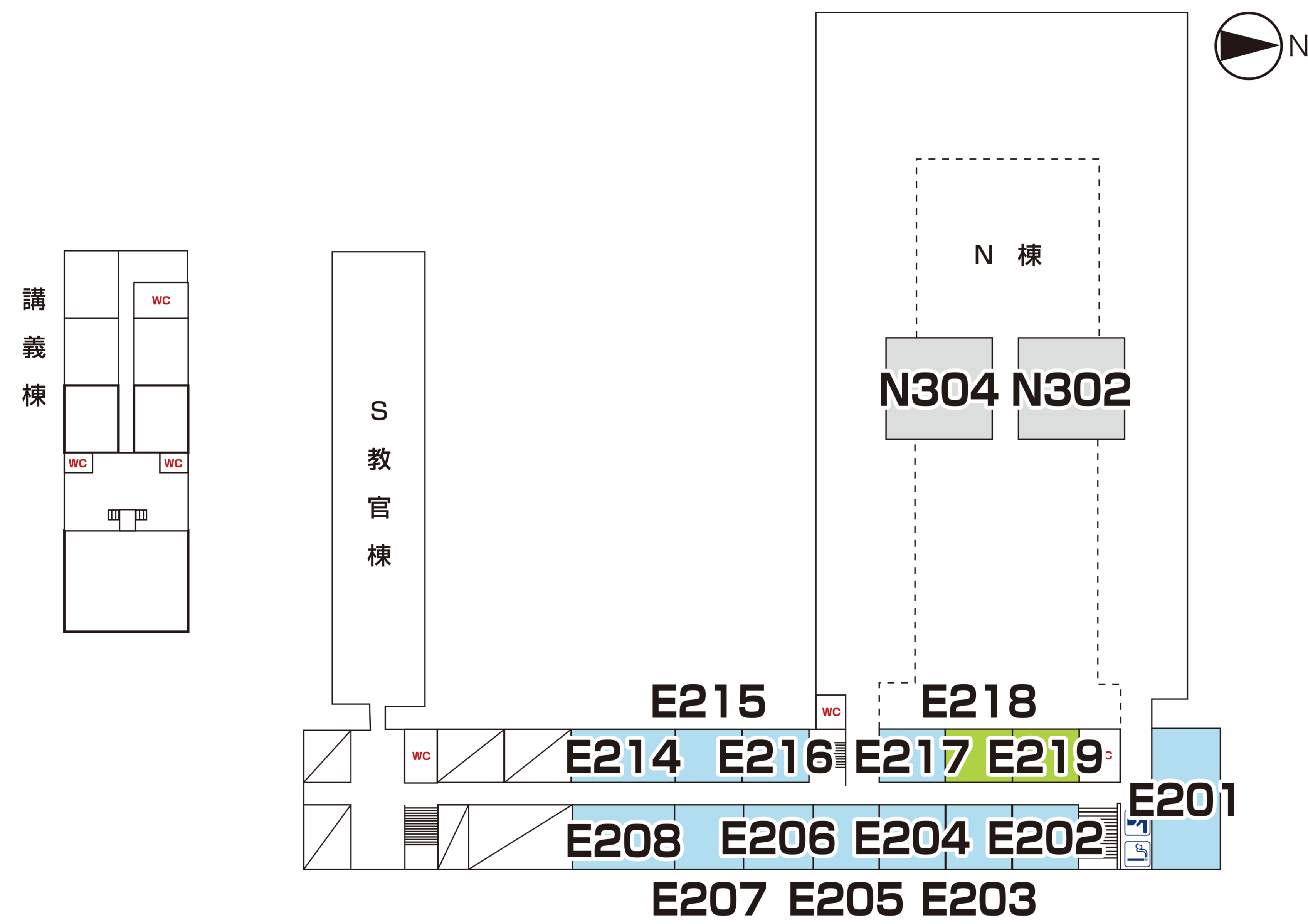

1F

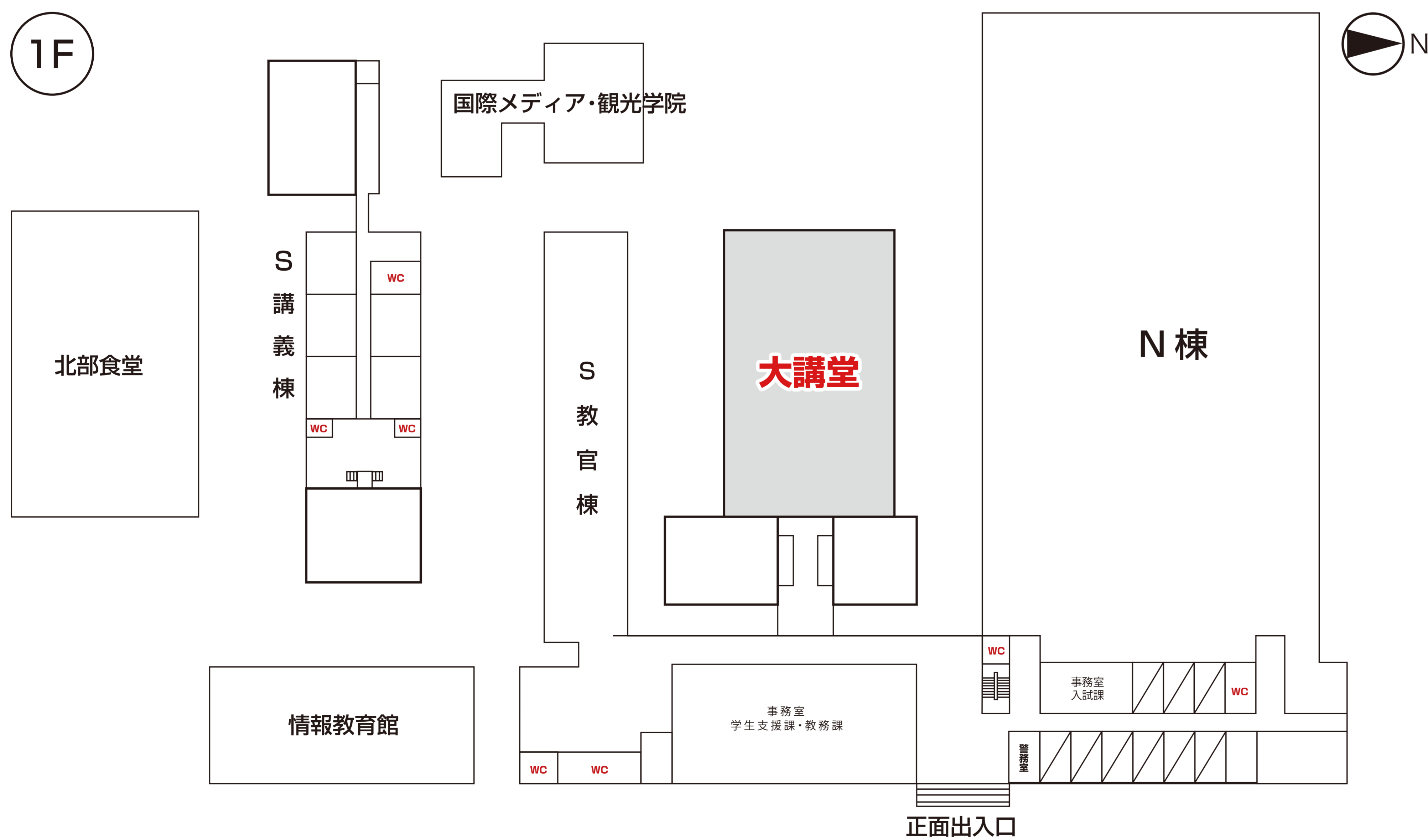

2F

- I-1 (E201教室)
- I-2 (E202教室)
- I-3 (E203教室)
- 3F I-4 8/29 9:00-10:20 (E304教室)
8/29 午後, 8/30, 8/31 (E204教室)

2F

- I-5 (E205教室)
- I-6 (E206教室)
- I-7 (E207教室)
- I-8 (E208教室)
- I-9 (E214教室)
- I-10 (E215教室)
- I-11 (E216教室)
- I-12 8/29 9:00-10:20 (E219教室)
8/30, 8/31 (E217教室)

3F

- II-1 (E218教室)
- II-2 (E219教室)
- II-3 (E301教室)
- II-4 (E302教室)
- III-1 (E303教室)
- III-2 (E304教室)
- III-3 (E305教室)
- III-4 (E306教室)
- III-5 8/29 午前 (E307教室)
8/29 15:20-16:40 (E310教室)
8/30, 8/31 (E307教室)
- III-6 (E308教室)
- III-7 8/29, 8/31 (E310教室)
8/30 10:40-12:00 (E311教室)

1F

- III-8 (E311教室)
- III-9 (E312教室)
- III-10 (E313教室)
- III-11 (E314教室)
- IV-1 (E315教室)
- IV-2 (E317教室)
- IV-3 (E318教室)
- IV-4 (E319教室)
- CS-1/III-12 (N302教室)
- CS-2/II-5 (N304教室)
- CS-3 (大講堂)

3F

- CS-4 8/29 15:20-16:40 (N304教室)
CS-4のその他の時間帯は工学部オープンホール